

TOSHIBA

MULTIFUNCTIONAL DIGITAL SYSTEMS

Safety Information

e-STUDIO2822AM/2822AF

e-STUDIO2523A/2523AD

e-STUDIO2323AM/2823AM

e-STUDIO2329A/2829A

- Read all the manuals carefully before using this product, and be sure to keep it for future reference.

© 2019 Toshiba Tec Corporation All rights reserved

Under the copyright laws, this manual cannot be reproduced in any form without prior written permission of Toshiba Tec Corporation.

Safety Information

■ Preface

Thank you for purchasing the Toshiba Multifunctional Digital Systems. The Safety Information describes the necessary precautions for using this product. For your added safety, be sure to read this booklet before using this product.

For the following items, refer to the Safety Information (PDF file) on the DVD; Trademarks, Environmental Information, etc.

The following table shows combinations of the model name indicated on the front cover and the model name given in the identification label.

Model name on the front cover	Model name on the identification label
e-STUDIO2822AM/2822AF	DP-2822AM/2822AF
e-STUDIO2523A/2523AD	DP-2523A/2523AD
e-STUDIO2323AM/2823AM	DP-2323AM/2823AM
e-STUDIO2329A/2829A	DP-2329A/2829A

If there is a model name in the note, the corresponding model is applicable. If not, the above models are applicable.

Example:

e-STUDIO2329A/2829A: This is a note for using e-STUDIO2329A/2829A.

■ Disclaimer Notice

The following notice sets out the exclusions and limitations of liability of TOSHIBA TEC CORPORATION (including its employees, agents and sub-contractors) to any purchaser or user ('User') of the e-STUDIO2822AM/2822AF, the e-STUDIO2523A/2523AD, the e-STUDIO2323AM/2823AM, or the e-STUDIO2329A/2829A, including its accessories, options and bundled software ('Product').

1. The exclusion and limitations of liability referred to in this notice shall be effective to the fullest extent permissible at law. For the avoidance of doubt, nothing in this notice shall be taken to exclude or limit TOSHIBA TEC CORPORATION's liability for death or personal injury caused by TOSHIBA TEC CORPORATION's negligence or TOSHIBA TEC CORPORATION's fraudulent misrepresentation.
2. All warranties, conditions and other terms implied by law are, to the fullest extent permitted by law, excluded and no such implied warranties are given or apply in relation to the Products.
3. TOSHIBA TEC CORPORATION shall not be liable for any loss, cost, expense, claim or damage whatsoever caused by any of the following:
 - (a) use or handling of the Product otherwise than in accordance with the manuals, including but not limited to Operator's Manual, User's Guide, and/or incorrect or careless handling or use of the Product;
 - (b) any cause which prevents the Product from operating or functioning correctly which arises from or is attributable to either acts, omissions, events or accidents beyond the reasonable control of TOSHIBA TEC CORPORATION including without limitation acts of God, war, riot, civil commotion, malicious or deliberate damage, fire, flood, or storm, natural calamity, earthquakes, abnormal voltage or other disasters;
 - (c) additions, modifications, disassembly, transportation, or repairs by any person other than service technicians authorized by TOSHIBA TEC CORPORATION; or

(d) use of paper, supplies or parts other than those recommended by TOSHIBA TEC CORPORATION.

4. Subject to paragraph 1, TOSHIBA TEC CORPORATION shall not be liable to Customer for:
- (a) loss of profits; loss of sales or turnover; loss of or damage to reputation; loss of production; loss of anticipated savings; loss of goodwill or business opportunities; loss of customers; loss of, or loss of use of, any software or data; loss under or in relation to any contract;
 - or
 - (b) any special, incidental, consequential or indirect loss or damage, costs, expenses, financial loss or claims for consequential compensation;

whatsoever and howsoever caused which arise out of or in connection with the Product or the use or handling of the Product even if TOSHIBA TEC CORPORATION is advised of the possibility of such damages.

TOSHIBA TEC CORPORATION shall not be liable for any loss, cost, expense, claim or damage caused by any inability to use (including, but not limited to failure, malfunction, hang-up, virus infection or other problems) which arises from use of the Product with hardware, goods or software which TOSHIBA TEC CORPORATION has not directly or indirectly supplied.

■ Security Precautions

In order to make correct use of this product's security function, first read the following precautions carefully. Be sure to assign administrators who have enough capability to sustain responsible management since significant privileges for managing and handling this equipment will be given them.

□ To Administrators

- To avoid physical security problems, such as hardware removal or inappropriate disassembly at the installation site, take all necessary measures, such as checking who enters and leaves the site.
- (Only for e-STUDIO2822AM/2822AF, e-STUDIO2323AM/2823AM, e-STUDIO2329A/2829A) When connecting this product with an outer network such as the Internet, only operate it in a network environment protected by a firewall, etc. to prevent information from being leaked due to incorrect settings or avoid illegal access by unauthorized users.
- (Only for e-STUDIO2822AM/2822AF, e-STUDIO2323AM/2823AM, e-STUDIO2329A/2829A) To prevent the configuration settings from being altered improperly or similar, before you use this product, change the administrator password set by factory default. Also, be sure periodically to change each password set for this product.
- (Only for e-STUDIO2822AM/2822AF, e-STUDIO2323AM/2823AM, e-STUDIO2329A/2829A) In order to make proper use of the network function and the department management function, be sure to read the TopAccess Guide and User's Guide first.
(Only for e-STUDIO2523A/2523AD) In order to make proper use of the department management function, be sure to read the User's Guide first.
- Be sure to understand the security policy and its procedure in your organization, and manage and operate this equipment according to the policy after first reading the operator's manual. Then explain the security instructions to general users who are authorized to use this equipment to let them conform to the security rule.
- Provide general users with the appropriate privilege of using this equipment and keep supervising its correct operation.

- (Only for e-STUDIO2822AM/2822AF, e-STUDIO2323AM/2823AM, e-STUDIO2329A/2829A) Always check if the network function or the department management function is enabled in order to maintain security. Should you happen to come across any abnormality, contact your service technician immediately. Refer to the TopAccess Guide and User's Guide for the checking method. (Only for e-STUDIO2523A/2523AD) Always check if the department management function is enabled in order to maintain security. Should you happen to come across any abnormality, contact your service technician immediately. Refer to the User's Guide for the checking method.

❑ To general users

- After you have finished operating the equipment, be careful not to forget to remove any originals, printed paper or USB storage devices.
- (Only for e-STUDIO2822AM/2822AF, e-STUDIO2323AM/2823AM, e-STUDIO2329A/2829A) Change the password regularly. Make sure not to use any predictable number such as your birthday or employee ID number, and keep it secret.
- Do not leave the equipment during the performance of the job since your originals may be seen or the output paper could be taken by someone.

■ Toshiba Quality is Second to None

It is recommended that genuine Toshiba supplies and parts be used to obtain optimum results.

Sample image of the toner label/markings

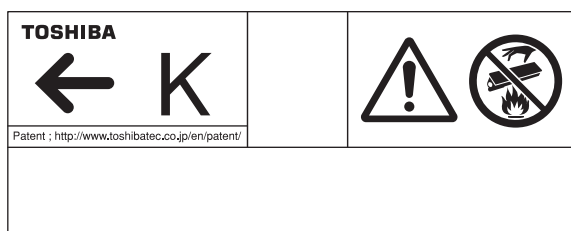

The contents of the label/markings differ depending on the model or destination.

❑ Supplies / Parts

- **Dependability**
Genuine Toshiba supplies are subjected to the strictest of inspections so that every supply you receive will perform at optimal levels.
- **High Productivity**
Genuine Toshiba supplies are created to meet the demands of our competitive world and provide highspeed reliable copies when you need them.
- **Stable Image Quality**
Genuine Toshiba supplies are designed to provide consistently stable image output.
- **MFP-friendly Supplies**
Genuine Toshiba supplies are designed to help to keep the MFP and all its parts in troublefree working order. Reduction of machine wear is due to Toshiba's intimate knowledge of the MFP's characteristics, ensuring the highest standard of care.
- **Perfectly Suited Supplies**
From the beginning Toshiba supplies and machines were made for each other. Whenever Toshiba designs a new machine, it also designs a new toner that is made just for that machine. By using Genuine Toshiba supplies with Toshiba MFPs, you are guaranteed optimum performance.

□ Toner

- **Optimum Image Quality**

Toshiba toner is manufactured using ultra-fine quality materials under precisely controlled conditions to ensure that your Toshiba MFPs will continually generate sharp high-quality images.

- **Cost Advantage**

Genuine Toshiba toner provides value. Only the proper amount of toner is used during the reproduction process, thereby enabling the machine to continue to operate until all the toner has been used. In this way you get the full value from each cartridge used.

- **Environmental Harmony**

Genuine Toshiba toner is manufactured with the environment in mind. To protect our planet for the benefit of future generations, we use embossed or plastic labels, making our toner cartridges fully recyclable. In addition, dust and ozone levels have been reduced to improve the working environment.

- **User Friendly**

Before approving our toners for sale, we test them to be sure that they pass the strictest of health standards. This takes all the worry out of handling the toner.

□ General

- **Service and Support Benefits**



Toshiba's Service technicians are certified to keep your MFP performing at optimum levels. To ensure continuous image quality, utilize an authorized Toshiba Service provider to care for and perform periodical maintenance on your MFP.

■ Notice to Users

- After a suitable place has been selected for the installation of the product, do not change it. Avoid excessive heat, dust, vibration and direct sunlight. Also, provide proper ventilation as the product emits a small amount of ozone.
- The unit is classified as Class 1 Laser Product according to IEC60825-1:2014 including amendments. The unit uses laser diode of output Max. 10 mW, wave length 785 nm or 793 nm, continuous pulse.

CAUTION - Use of controls or adjustments or performance of procedures other than those specified herein may result in hazardous radiation exposure.

WARNING - This is a Class A product. In a domestic environment this product may cause radio interference in which case the user may be required to take adequate measures.

	WARNING - Laser Radiation Indicates that the products affixing this mark use laser and potential risk and hazard of eye or optic damage and/or skin burns if not avoided. Please follow the cautions described near this mark.
	CAUTION - Hot Surface Indicates that the locations affixing this mark are high temperature and have potential risk and hazard of skin burns and/or relating damage if not avoided. Please do not touch the location and its peripheral area.
	CAUTION - Moving parts Indicates that moving parts are in the vicinity and may cause pain if your hands or any other parts of your body should contact them or nearby. Please keep your hands and the rest of your body away from moving parts.

For the U.S.A. only**Supplier's Declaration of Conformity**

This equipment has been tested and found to comply with the limits for a Class A digital device, pursuant to Part 15 of the FCC Rules. These limits are designed to provide reasonable protection against harmful interference when the equipment is operated in a commercial environment. This equipment generates, uses and can radiate radio frequency energy and, if not installed and used in accordance with the instruction manual, may cause harmful interference to radio communications. Operation of this equipment in a residential area is likely to cause harmful interference in which case the user will be required to correct the interference at his own expense.

WARNING

Changes or modification made to this equipment, not expressly approved by Toshiba Tec Corporation or parties authorized by Toshiba Tec Corporation, could void the user's authority to operate the equipment.

Toshiba America Business Solutions, Inc.
25530 Commercentre Drive
Lake Forest, CA 92630
Tel: 949-462-6000

User Safety

This product does not produce laser radiation hazardous to the user. It is certified as a Class 1 laser product under the U.S Department of Health and Human Services (DHHS) Radiation Performance Standard according to the Radiation Control Health and Safety Act of 1968 including amendments. Protective housing and external covers completely confine the laser beam light emitted inside the product. The laser beam cannot escape from the product during any phase of user operation. Regulations implemented on August 2, 1976 by the Bureau of Radiological Health (BRH) of the U.S Food and Drug Administration apply to laser products manufactured from August 1, 1976. Laser products marketed in the United States must comply with these regulations.

CAUTION

Use of controls or adjustments or performance of procedures other than those specified herein may result in hazardous radiation exposure.

For the U.S.A. and Canada**Regulatory Information**

Toshiba is dedicated to preserving the environment by sponsoring Call2Recycle, a program of the Rechargeable Battery Recycling Corporation. For more information and for drop-off locations, visit www.rbrc.org or call 1-800-822-8837.

Notice regarding CR coin cell batteries, applicable to California, U.S.A. only: Perchlorate Material - special handling may apply.

See <http://www.dtsc.ca.gov/hazardouswaste/perchlorate/>

For Canada only

This Class A digital apparatus complies with Canadian ICES-003. (CAN ICES-3 (A))
Cet appareil numérique de la classe A est conforme à la norme NMB-003 du Canada. (CAN NMB-3 (A))

For Europe only

Working environment

From EMC (Electromagnetic Compatibility) point of view, the operation of this product is being restricted in following environments:

- Medical Environments: This product is not certified as a medical product according to the Medical Device Regulations (2017/745).
- Domestic environments (e.g. a private living room with TV / Radio sets in the nearby surrounding area) because this is a so called EMC class A product. In a domestic environment this product may cause radio interference in which case the user may be required to take adequate measures!

Any consequences resulting from the use of this product in restricted working environments are not the responsibility of Toshiba Tec Corporation.

The consequences of the use of this product in restricted working environments may be an electromagnetic interference with other devices or machines in the nearby surrounding area. This can result into malfunction including data loss / data error pertaining to this product or the other devices / machines involved in the electromagnetic interference.

Furthermore, for general safety reasons, the use of this product in environments with explosive atmospheres is not permitted.

CE compliance

This product is labelled with the CE mark in accordance with the provisions of the applicable European Directives, notably the Low Voltage Directive 2014/35/EU, the Electromagnetic Compatibility Directive 2014/30/EU, the RoHS Directive 2011/65/EU, (EU) 2015/863 for this product and the electric accessories.

CE marking is the responsibility of TOSHIBA TEC GERMANY IMAGING SYSTEMS GmbH, Carl-Schurz-Str. 7, 41460 Neuss, Germany, phone +49-(0)-2131-1245-0.

For a copy of the related CE Declaration of Conformity, please contact your dealer or Toshiba Tec Corporation.

WARNING - This is a Class A product. In a domestic environment this product may cause radio interference in which case the user may be required to take adequate measures.



This product is marked according to the requirement in EU-Directive on Waste electrical and electronic equipment - WEEE.

The use of the symbol indicates that this product may not be disposed as unsorted municipal waste and has to be collected separately. By ensuring this product is disposed of correctly, you will help prevent potential negative consequences for the environment and human health, which could otherwise be caused by inappropriate waste handling of this product.

For more detailed information about the take-back and recycling of this product please contact your supplier where you purchased the product.

Following information is for EU-member states only:



Disposal of batteries and/or accumulators based on EU-Directive on batteries and accumulators and waste batteries and accumulators.

By ensuring that batteries and/or accumulators are disposed of correctly, you will help prevent potential negative consequences for the environmental and human health, which could otherwise be caused by inappropriate waste handling of this product.

For more detailed information about the take-back and recycling of batteries and/or accumulators, please contact your supplier where you purchased this product.

This device is not intended for use in the direct field of view at visual display workplaces.

To avoid incommoding reflections at visual display workplaces this device must not be placed in the direct field of view.

For India only

Following information is only for India:



The use of the symbol indicates that this product may not be treated as household waste. By ensuring this product is disposed of correctly, you will help prevent potential negative consequences for the environment and human health, which could otherwise be caused by inappropriate waste handling of this product.

For more detailed information about the take-back and recycling of this product, please contact your supplier where you purchased the product.

This product including components, consumables, parts and spares complies with the "India E-Waste Rules" and prohibits use of lead, mercury, hexavalent chromium, polybrominated biphenyls or polybrominated diphenyl ethers in concentrations exceeding 0.1% by weight and 0.01% by weight for cadmium, except for the exemption set in the Rule.

For Argentina only

Following information is only for the province of Buenos Aires in Argentina:



La siguiente información es solo para Argentina

El uso de este símbolo indica que este producto no puede ser tratado como residuos domésticos.

Asegúrese que este producto se deseché correctamente, Usted ayudara a evitar posibles consecuencias negativas para el medio ambiente y la salud humana, que podrían derivarse de la incorrecta manipulación de este producto.



Para mas información sobre el reciclaje de este producto, consulte con nuestro.

For Turkey only

Following information is only for Turkey:

AEEE Yönetmeliğine Uygundur

For China only

	Indicates that the products affixing this mark can be used in areas other than tropical climate area in China.
	Indicates that the products affixing this mark can be used in areas up to 2000 m above sea level in China.





For Thailand, Singapore, China and Canada

A take-back program for products, toner cartridges and waste toner boxes is available for each of the above countries. To return them, please do so in accordance with the contract between the supplier and the consumer or contact your supplier where you purchased the product.

■ General Precautions

□ Symbols in this manual

In this manual, some important items are described with the symbols shown below. Be sure to read these items before using this equipment.

-  **WARNING** Indicates a potentially hazardous situation which, if not avoided, could result in death, serious injury, or serious damage, or fire in the equipment or surrounding objects.
-  **CAUTION** Indicates a potentially hazardous situation which, if not avoided, may result in minor or moderate injury, partial damage to the equipment or surrounding objects, or loss of data.
-  **Note** Indicates information to which you should pay attention when operating the equipment.
-  **Tip** Describes handy information that is useful to know when operating the equipment.
-  Pages describing items related to what you are currently doing. See these pages as required.

□ When installing or moving

WARNING

- The required electric power is as follows;
 - **The U.S.A. and Canada:** 120 V, 12 A, 50/60 Hz
 - **Europe:** 220 to 240 V AC, 8 A, 50/60 Hz
 - **Other than those above:** 220 to 240 V AC, 8 A, 50/60 Hz
- Do not use a power supply with a voltage other than that specified.
Avoid multiple connections in the same outlet. This could cause a fire or give you an electric shock. If you are considering increasing the number of outlets, contact an electrician.
- Always connect this product to an outlet with a ground connection to avoid the danger of fire or electric shock in case of short-circuiting. Contact your service representative for the details. Be sure to use a 3-conductor, grounded wall outlet.

In areas, except the U.S. and Canada, where a 2-pin plug is used, this product must be grounded for safety. Never ground it to a gas pipe, a water pipe, or any other object not suitable for grounding.

- Plug the power cord securely into the outlet. If it is not plugged in properly, it could heat up and cause a fire or give you an electric shock.
- Do not damage, break or attempt to repair the power cord.
The following things should not be done to the power cord.

- Twisting it
- Bending it
- Pulling it
- Placing anything on it
- Heating
- Situating it near radiators or other heat sources

This could cause a fire or give you an electric shock. If the power cord is damaged, contact your service representative.

- The socket outlet shall be near the equipment and be easily accessible.
- Pull out the plug from the outlet more than once a year to clean around the prongs. Accumulating dust and dirt could cause a fire due to the heat released by electric leakage.

CAUTION

- Avoid placing the equipment in a place unsuitable for its weight and also make sure the surface is level. Remember that if the equipment falls over, serious injuries could result. For the weight of the equipment, refer to the User's Guide.
- Do not install the equipment by yourself or try to move it once it has been installed. This could result in an injury or damage to the device. Contact your service representative if the equipment needs to be installed or moved.
- (**e-STUDIO2822AM/2822AF**) When moving the equipment, pull out the drawer and then have two or more persons hold the portions indicated below. If not, this could cause malfunctioning or an injury.

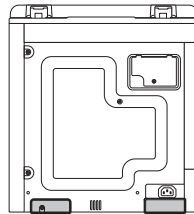
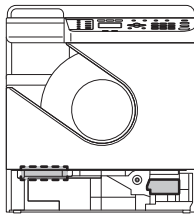

- When removing the plug from the outlet, do not pull the power cord. Always hold the plug when removing it from the outlet. If the power cord is pulled, the wires may break and this could cause a fire or give you an electric shock.
- Make sure that the ventilation holes are not blocked.
If the temperature within this equipment becomes too high, a fire could result.
- When connecting the interface cable to the equipment, be sure to turn the power OFF. If the power is not turned off, you could get an electric shock.

- **(e-STUDIO2329A/2829A)** The Paper Feed Pedestal has 6 adjusters (antiskid devices) underneath. Be sure to confirm that this equipment is securely fixed on the floor with them. If not, turn and lower them to do so.

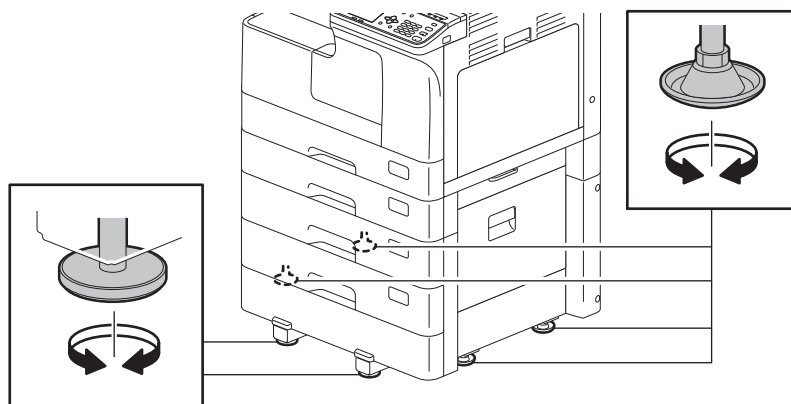

Other points

- If there is insufficient space around the equipment, the poor ventilation will result in malfunction, also some operations such as bypass feeding and releasing paper misfeeds may become difficult. To ensure adequate space, follow the table below as a guide.

Adequate space		
Rear	Left	Right
20 cm (7.9")	30 cm (11.8")	80 cm (31.5")

- Be sure to fix the power cable securely so that no one trips over it.
- Adverse environmental conditions may affect the safe operation and performance of the equipment, and the equipment could break down.
 - Avoid locations near windows or with exposure to direct sunlight.
 - Avoid locations with drastic temperature fluctuations.
 - Avoid too much dust.
 - Avoid locations that suffer from vibration.
- Make sure that the air is able to flow freely and that there is sufficient ventilation. Without adequate ventilation, the unpleasant odor released by ozone will begin to dominate the atmosphere.

□ When using the product

⚠ WARNING

- Do not take off the cover of the equipment; otherwise you could be injured or get an electric shock.
- Do not remove or connect the plug with wet hands, as this could give you an electric shock.
- Do not place any container with liquid (flower vases, coffee cups, etc.) on or near the equipment. This could cause a fire or give you an electric shock.
- Keep paper clips and staples away from the air vent. If not, a fire could result or you could get an electric shock.
- If the equipment becomes excessively hot, smoke comes out of it or there is an odd smell or noise, proceed as follows.
Turn the main power switch OFF and remove the plug from the outlet, then contact your service representative.

- If the equipment will not be used for more than one month, remove the plug from the outlet for safety purposes during that time. If an insulation failure occurs, this could cause a fire or give you an electric shock.
- Do not touch any portions other than those specified in the Operator's Manual. This could cause a malfunction, or you could get an electric shock, be injured or burned.

CAUTION

- Do not place heavy objects (4 kg/9 lb. or over) on the original glass and do not press on it with force. Breaking the glass could cause personal injury.
- Do not place heavy objects (4 kg/9 lb. or over) on the equipment. If the objects fall off, this could cause injury.
- (**e-STUDIO2822AM/2822AF**) Be sure to hold the drawer with both hands and be careful not to let it fall when removing or installing it. If you drop it, it could injure you.
- Be careful not to catch your fingers when closing the drawer. This could cause an injury.
- Do not touch the fuser unit or the metal area around it. Since they are very hot, you could be burned or the shock could cause you to injure your hand in the machine.

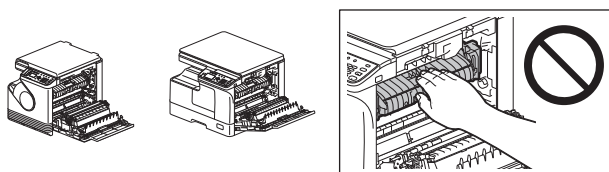

- Be careful not to catch your fingers between the equipment and the side cover. This could cause an injury.

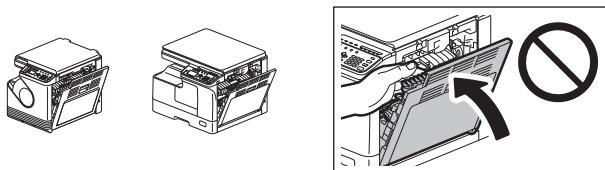

- When you open or close the Automatic Document Feeder or Reversing Automatic Document Feeder, be careful not to catch your fingers between its rear side and the equipment. This could injure you.
- Do not use the pulled out drawers as steps. This could injure you if you fall.

Other points

- Do not turn the power OFF with misfed paper remaining inside the equipment. This could cause a malfunction when the power is turned ON next time.
- Be sure to turn the power OFF when leaving the office or if there is a power outage. However, do not turn the power OFF if the weekly timer is in use.
- Be careful because the paper exit area and paper just after exiting are hot.
- Do not place anything other than paper on the receiving tray. This could disturb a normal operation and cause malfunctions.
- Do not touch the photoconductive drum. This could cause image problems.

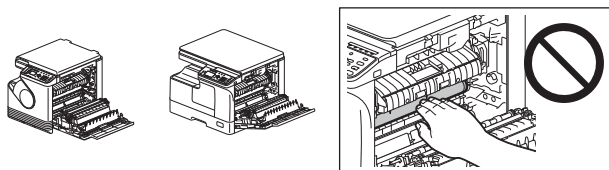

-
- Do not open/close the covers and the bypass tray, or pull out the drawers during printing.

□ **During maintenance or inspection**

⚠ **WARNING**

- Never attempt to repair, disassemble or modify the product by yourself. This could cause a fire or give you an electric shock or injury.
Always contact your service representative for maintenance or repair of the internal parts of the product.
- Do not let liquids such as water and oil get into the product when cleaning the floor. This could cause a fire and give you an electric shock.
- Pull out the plug from the outlet more than once a year to clean around the prongs. Accumulating dust and dirt could cause a fire due to the heat released by electric leakage.

Other points

- Do not use such solvents as thinner or alcohol when cleaning the surface of the product.
 - This could warp the shape of the surface or leave it discolored.
 - When using a chemical cleaning pad to clean it, pay attention to any cautionary points.
 - Repair parts will be provided for a period of 7 years after the final manufacturing of the product.
 - The life of each consumable differs depending not only on the copy/print volume but also on other factors (operating time, output image, media type and so on). Due to this, the life cannot be specified in a simple description using the copy/print volume. For more details, contact your supplier where you purchased the product.

□ **When handling supplies**

⚠ **CAUTION**

- Never attempt to incinerate toner cartridges. Dispose of used toner cartridges in accordance with local regulations.

Other points

- Read the operator's manual carefully to replace the toner cartridge using the correct procedure. An improper procedure could cause toner leakage or scattering.
- Do not open the toner cartridge forcibly. This could cause toner leakage or scattering.
- Keep the toner cartridge out of the reach of children.
- If toner is spilt on your clothes, wash it off with cold water. If you use warm water, your clothes will be permanently stained with toner because it will not come out .
- If toner leaks from the toner cartridge, be careful not to inhale or touch it.

First-aid measures

If you inhale or touch toner, etc; carry out the following treatment.

- Inhalation: Remove from exposure area to fresh air immediately. Contact a physician if there is any difficulty in breathing or other signs of distress.
- Skin Contact: Wash with soap and water. Wash clothing before reuse. If irritation occurs or is persistent, seek medical attention.
- Eye Contact: Immediately flush eyes with plenty of water for at least 15 minutes. If irritation persists, call a physician.
- Ingestion: Dilute stomach contents with several glasses of water.

❑ Wireless and your Health

Wireless LAN products, like other radio devices, emit radio frequency electromagnetic energy. The level of energy emitted by Wireless devices however is far much less than the electromagnetic energy emitted by wireless devices like for example mobile phones.

Because Wireless LAN products operate within the guidelines found in radio frequency safety standards and recommendations, Toshiba Tec Corporation believes Wireless LAN module is safe for use by consumers. These standards and recommendations reflect the consensus of the scientific community and result from deliberations of panels and committees of scientists who continually review and interpret the extensive research literature.

In some situations or environments, the use of Wireless LAN may be restricted by the proprietor of the building or responsible representatives of the organization. These situations may for example include:

- Using the Wireless LAN equipment on board of aeroplanes, or
- In any other environment where the risk of interference to other devices or services is perceived or identified as harmful.

If you are uncertain of the policy that applies on the use of wireless devices in a specific organization or environment (e.g. airports), you are encouraged to ask for authorization to use the Wireless LAN devices prior to turning on the equipment.

Note

- Wireless LAN operate within the same radio frequency range and may interfere with one another. If you use Wireless LAN devices simultaneously, you may occasionally experience a less than optimal network performance or even lose your network connection.
- If you should experience any such problem, immediately turn off your Wireless LAN network.

The frequency bands and maximum output power of GN-1160

- Frequency Band: 2.4 GHz (2412 to 2462 MHz)
- Transmitter Power: Max. 20 dBm

□ Position of certification labels, etc.

e-STUDIO2822AM/2822AF

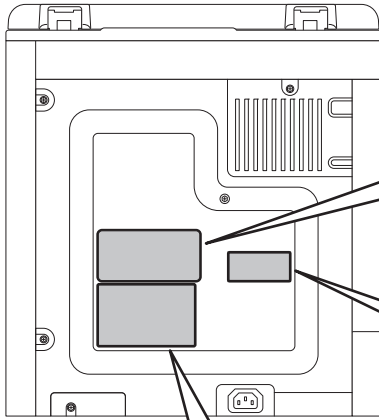





Explanatory label



Certification label (For the U.S.A. and Canada)



Identification label

<p>For the U.S.A. and Canada</p> <p>TOSHIBA MULTIFUNCTIONAL DIGITAL SYSTEMS /SYSTEME MULTIFONCTION NUMERIQUE e-STUDIO2822AM MODEL/MODELE DP-2822AM 120V ~ 50/60Hz 12A NO.</p> <p> TC LISTED I.T.E. E201821</p> <p>TOSHIBA TEC CORPORATION TC MADE IN CHINA/FABRIQUE EN CHINE</p>	<p>For Europe</p> <p>TOSHIBA MULTIFUNCTIONAL DIGITAL SYSTEMS /SYSTEME MULTIFONCTION NUMERIQUE e-STUDIO2822AM MODEL/MODELE DP-2822AM 220-240V ~ 50/60Hz 8A NO.</p> <p>   </p> <p>TOSHIBA TEC CORPORATION TC MADE IN CHINA/FABRIQUE EN CHINE</p>
---	---

Warning label

危険、ドラムユニットを外したり光学ユニットを開けたときトアスイッチを無効にするときクラス3Bの不可視レーザー放射の恐れあり、ビームの直接暴露を避けて。
DANGER-CLASS 3B INVISIBLE LASER RADIATION WHEN OPTICAL UNIT OPEN OR DRUM UNIT REMOVED AND INTERLOCK DEFATED, AVOID DIRECT EXPOSURE TO BEAM.
VORSICHT-KLASSE 3B UNBICHTBARE LASERSTRAHLUNG WENN DIE ABDECKUNG GEÖFFNET ODER DIE TROMMEL ENTFERNT UND DIE VERRIEGELUNG UNWIRKSAM GEMACHT WIRD, NICHT DIREKT DEM STRAHL AUSSETZEN.
DANGER-CLASSE 3B RAYON LASER INVISIBLE LORSQUE LE BLOC OPTIQUE EST COUVERT, LE TAMBOUR RETIRE ET LE VERRIQUILLAGE HORS D'USAGE, EVITER L'EXPOSITION DIRECTE AU RAYON.
PELIGRO-RADIACION INVISIBLE DE LASER CLASE 3B CUANDO LA UNIDAD OPTICA ESTA ABIERTA O LA UNIDAD DEL CILINDRO ES RETIRADA Y CUANDO EL INTERRUPTOR DE SEGURIDAD ESTA DE SACTIVADO, EVITE EXPOSICION DIRECTA AL RAYO.

Warning label

危険、ドラムユニットを外したり光学ユニットを開けたときトアスイッチを無効にするときクラス3Bの不可視レーザー放射の恐れあり、ビームの直接暴露を避けて。
DANGER-CLASS 3B INVISIBLE LASER RADIATION WHEN OPTICAL UNIT OPEN OR DRUM UNIT REMOVED AND INTERLOCK DEFATED, AVOID DIRECT EXPOSURE TO BEAM.
VORSICHT-KLASSE 3B UNBICHTBARE LASERSTRAHLUNG WENN DIE ABDECKUNG GEÖFFNET ODER DIE TROMMEL ENTFERNT UND DIE VERRIEGELUNG UNWIRKSAM GEMACHT WIRD, NICHT DIREKT DEM STRAHL AUSSETZEN.
DANGER-CLASSE 3B RAYON LASER INVISIBLE LORSQUE LE BLOC OPTIQUE EST COUVERT, LE TAMBOUR RETIRE ET LE VERRIQUILLAGE HORS D'USAGE, EVITER L'EXPOSITION DIRECTE AU RAYON.
PELIGRO-RADIACION INVISIBLE DE LASER CLASE 3B CUANDO LA UNIDAD OPTICA ESTA ABIERTA O LA UNIDAD DEL CILINDRO ES RETIRADA Y CUANDO EL INTERRUPTOR DE SEGURIDAD ESTA DE SACTIVADO, EVITE EXPOSICION DIRECTA AL RAYO.

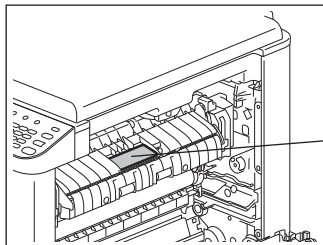

Warning for high temperature area (Fuser unit)

e-STUDIO2523A/2523AD/2323AM/2823AM/2329A/2829A

Identification label

For the U.S.A. and Canada

TOSHIBA
 MULTIFUNCTIONAL DIGITAL SYSTEMS
 /SYSTEME MULTIFONCTION NUMERIQUE e-STUDIO2829A
 MODEL/MODELE DP-2829A
 120V ~ 12A
 50/60Hz NO.



TOSHIBA TEC CORPORATION TC
 MADE IN CHINA/FABRIQUE EN CHINE

For Europe

TOSHIBA
 MULTIFUNCTIONAL DIGITAL SYSTEMS
 /SYSTEME MULTIFONCTION NUMERIQUE e-STUDIO2829A
 MODEL/MODELE DP-2829A
 220-240V ~ 8A
 50/60Hz NO.



TOSHIBA TEC CORPORATION TC
 MADE IN CHINA/FABRIQUE EN CHINE

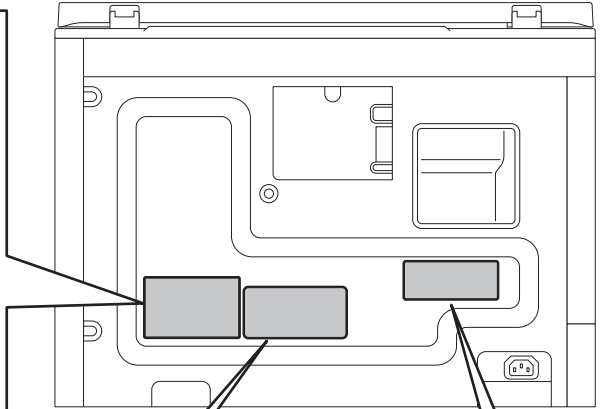

Explanatory label

CLASS 1 LASER PRODUCT
 APPAREIL À LASER DE CLASSE 1
 LASER KLASSE 1
 PRODUCTO DE LASER DE CLASE 1
 クラス1レーザー製品

>PS<

**Certification label
 (For the U.S.A. and Canada)**

Product is certified by the manufacturer to comply with DHHS Rule 21 CFR subchapter J applicable at the date of Manufacture.

Manufactured: TS

TOSHIBA TEC CORPORATION
 1-11-1, OSAKI, SHINAGAWA-KU, TOKYO, 141-8562, JAPAN

Warning label



>PS<

危険-ドラムユニットを外したり光学ユニットを開けたら射光スイッチを無効にする。クラス3Bの不可視レーザー放射の恐れあり。ビームの直接曝露を避ける。

DANGER-CLASS 3B INVISIBLE LASER RADIATION WHEN OPTICAL UNIT OPEN OR DRUM UNIT REMOVED AND INTERLOCK DEFATED. AVOID DIRECT EXPOSURE TO BEAM.

VORSICHT-KLASSE 3B UNVISIBLE LASER STRAHLLUNG, WENN DIE ABDECKUNG GEÖFFNET ODER DIE TROMMEL ENTFERNT UND DIE VERREGELUNG UNWIRKSAM GEMACHT WIRD. NICHT DIREKT DEM STRAHL AUSSETZEN.

DANGER-CLASSE 3B RAYON LASER INVISIBLE LORSQUE LE BLOC OPTIQUE EST COUVERT, LE TAMBOUR RETIRE ET LE VERROUILLAGE HORS D'USAGE. EVITER L'EXPOSITION DIRECTE AU RAYON.

PELIGRO-RADIACION INVISIBLE DE LASER CLASE 3B CUANDO LA UNIDAD OPTICA ESTA ABIERTA O LA UNIDAD DEL CILINDRO ES RETIRADA Y CUANDO EL INTERRUPTOR DE SEGURIDAD ESTA DE SACTIVADO. EVITE EXPOSICION DIRECTA AL RAYO.

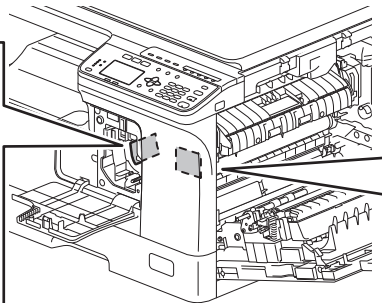

Warning label



>PS<

危険-ドラムユニットを外したり光学ユニットを開けたら射光スイッチを無効にする。クラス3Bの不可視レーザー放射の恐れあり。ビームの直接曝露を避ける。

DANGER-CLASS 3B INVISIBLE LASER RADIATION WHEN OPTICAL UNIT OPEN OR DRUM UNIT REMOVED AND INTERLOCK DEFATED. AVOID DIRECT EXPOSURE TO BEAM.

VORSICHT-KLASSE 3B UNVISIBLE LASER STRAHLLUNG, WENN DIE ABDECKUNG GEÖFFNET ODER DIE TROMMEL ENTFERNT UND DIE VERREGELUNG UNWIRKSAM GEMACHT WIRD. NICHT DIREKT DEM STRAHL AUSSETZEN.

DANGER-CLASSE 3B RAYON LASER INVISIBLE LORSQUE LE BLOC OPTIQUE EST COUVERT, LE TAMBOUR RETIRE ET LE VERROUILLAGE HORS D'USAGE. EVITER L'EXPOSITION DIRECTE AU RAYON.

PELIGRO-RADIACION INVISIBLE DE LASER CLASE 3B CUANDO LA UNIDAD OPTICA ESTA ABIERTA O LA UNIDAD DEL CILINDRO ES RETIRADA Y CUANDO EL INTERRUPTOR DE SEGURIDAD ESTA DE SACTIVADO. EVITE EXPOSICION DIRECTA AL RAYO.

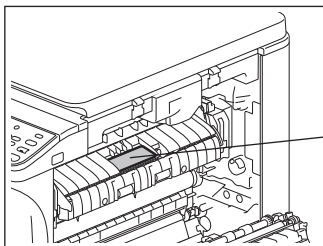

Warning for high temperature area (Fuser unit)

Other Information

■ Trademarks

- Microsoft, Windows, Windows NT, and the brand names and product names of other Microsoft products are trademarks of Microsoft Corporation in the US and other countries.
- Apple, AppleTalk, Macintosh, Mac, Mac OS, Safari, iPhone, iPod touch, TrueType, AirPrint, AirPrint logo, and iPad are trademarks of Apple Inc.
- IOS is a trademark or registered trademark of Cisco in the U.S. and other countries and is used under license.
- Adobe®, Acrobat®, Reader, and PostScript® are trademarks or registered trademarks of Adobe Systems Incorporated.
- Mozilla®, Firefox® and the Firefox logo® are trademarks or registered trademarks of Mozilla Foundation in the U.S. and other countries.
- e-STUDIO, e-BRIDGE, and TopAccess are trademarks of Toshiba Tec Corporation.
- Other company names and product names in this manual are the trademarks of their respective companies.

■ Official Names of Windows Operating System

- The official name of Windows® 7 is Microsoft Windows 7 Operating System.
- The official name of Windows® 8.1 is Microsoft Windows 8.1 Operating System.
- The official name of Windows® 10 is Microsoft Windows 10 Operating System.
- The official name of Windows Server® 2008 is Microsoft Windows Server 2008 Operating System.
- The official name of Windows Server® 2012 is Microsoft Windows Server 2012 Operating System.
- The official name of Windows Server® 2016 is Microsoft Windows Server 2016 Operating System.

■ Environmental Information

□ ENERGY STAR® Program

Toshiba Tec Corporation is a member of the ENERGY STAR Program. In all our products which meet the ENERGY STAR Program requirements, the ENERGY STAR logo can be confirmed on the label attached to the equipment or from the screen display.



The ENERGY STAR Program aims at the promotion of the development and wider usage of office equipment including energy-efficient computers in order to address environmental issues such as global warming. Manufacturers that participate in this program can attach the ENERGY STAR logo to products after confirming that they meet the energy saving standards of this program. Also, these standards and logo are commonly used within the U.S. Environmental Protection Agency (EPA) and participating countries.

Specified products, sales countries or regions may not be included.

To distinguish whether or not the product meets the ENERGY STAR Program requirements, check if the corresponding logo is attached on the equipment by the label or is displayed on the screen. If you have any questions, contact your service representative.

Printed in China
DP-2822AM/2822AF
DP-2523A/2523AD
DP-2323AM/2823AM
DP-2329A/2829A
OME18000300

MULTIFUNCTIONAL DIGITAL SYSTEMS

Safety Information

e-STUDIO2822AM/2822AF

e-STUDIO2523A/2523AD

e-STUDIO2323AM/2823AM

e-STUDIO2329A/2829A

Toshiba Tec Corporation

1-11-1, OSAKI, SHINAGAWA-KU, TOKYO, 141-8562, JAPAN

©2019 Toshiba Tec Corporation All rights reserved
Patent; <http://www.toshibatec.com/en/patent/>



6LL24606000
R180420U6700-TTEC
Ver00 F1 Issued in May 2019